



Installation Instructions

RB 500 Manual Roller Shades

Heavy Duty Clutch System

5-211 Series-Chain Operation

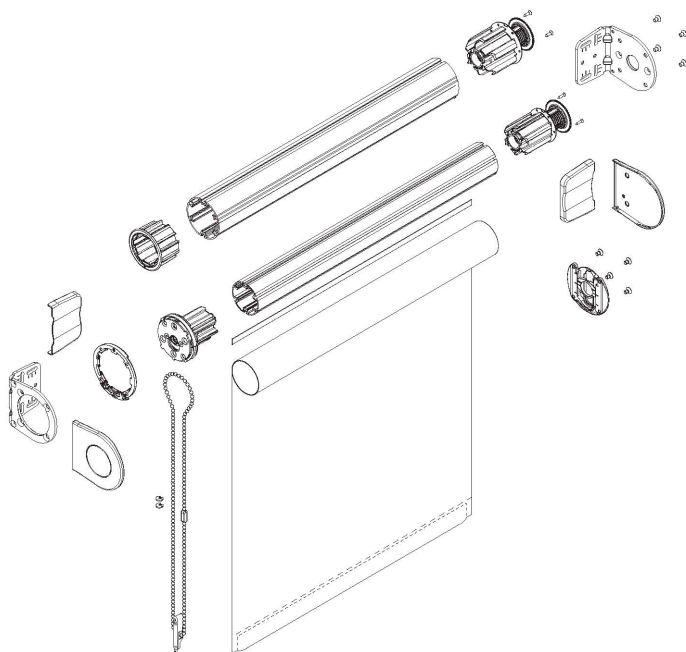

HunterDouglasHospitality

Installation

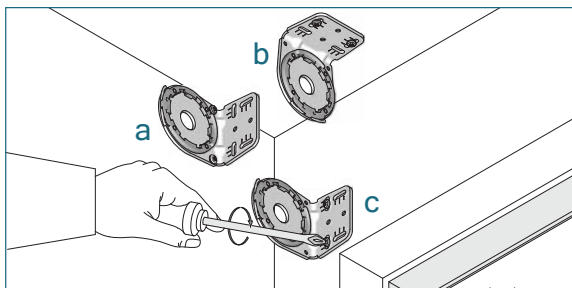

Install the brackets with the screws provided.

a) recess b) ceiling c) wall

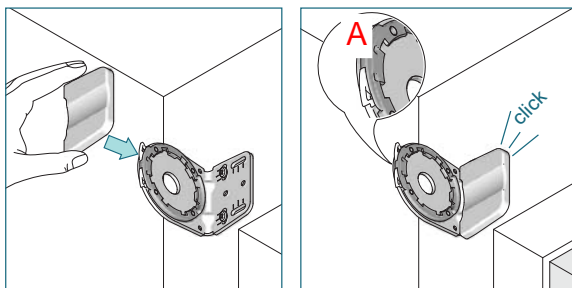

Slide the screw cover onto the bracket until it snaps.

Open the fastener on the bracket adapter (A).

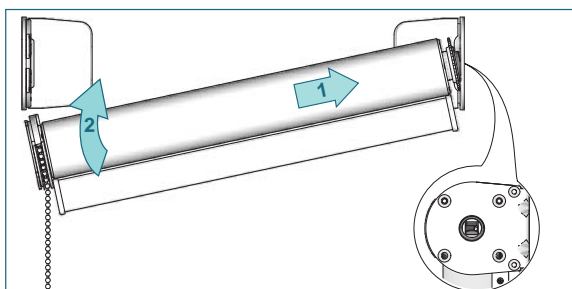

Place the roller shade with the idle end onto the bracket. Push the shade against the idle end and lift the shade up with the chain facing straight down...

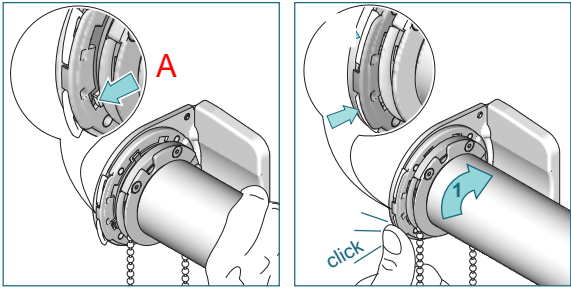

...line up teeth of the clutch with bracket adapter (A). Insert clutch into bracket, turn shade (10°) in the rolling off direction(1), and close fastener on the bracket adapter.

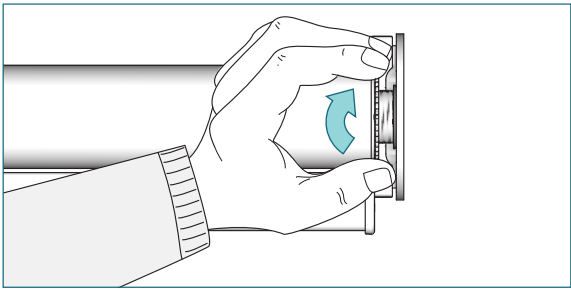

Secure the shade by turning the locking ring furthest away from the bracket.

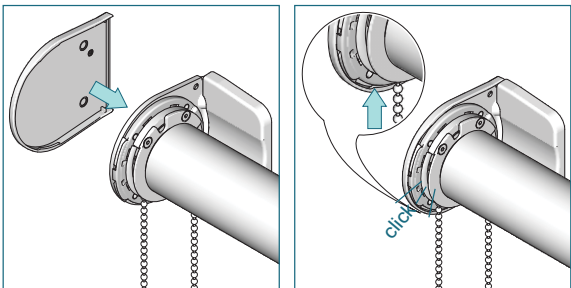

Attach the bracket covers onto the brackets. Make sure the bracket covers snap onto the brackets.

Option: Leveler

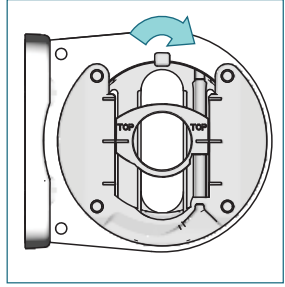
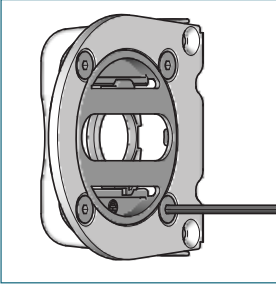

Make sure that the opening for the Allen key is pointing downwards before installing the brackets. Change the orientation by loosening the 4 screws and turning the leveler 90°. Reinstall the screws.

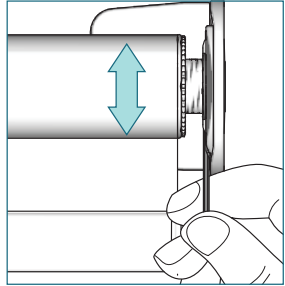
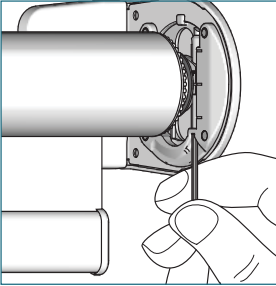

To adjust skewing, put the provided Allen key into the screw of the leveler and turn it left or right to move the shade up and down. Support lifting of large heavy roller shades with the palm of your hand.

Removal

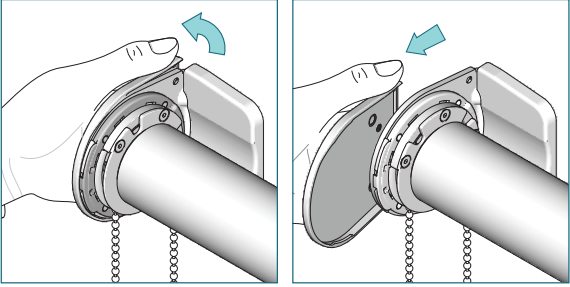

Lift the backside of the end cap and slide it towards you.

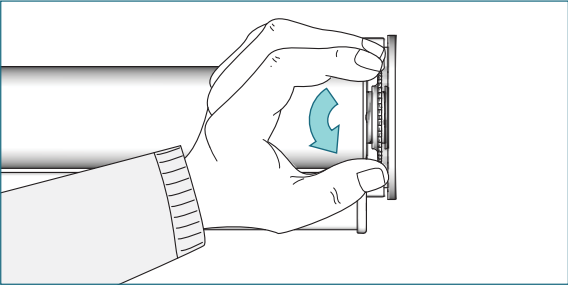

Unfasten the locking ring.

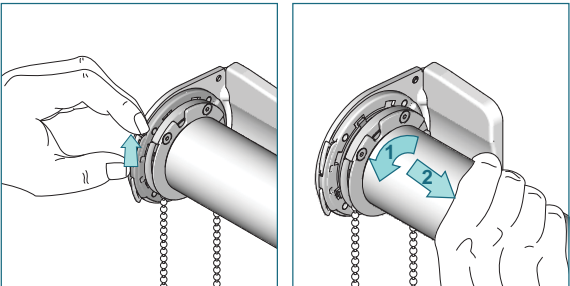

Open fastener on the bracket adapter. Turn the roller shade 10° in the roll up direction(1). Pull clutch out of the bracket adapter (2).

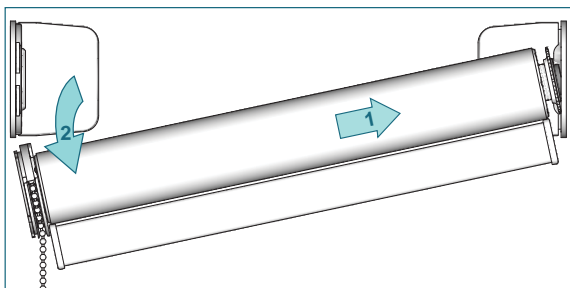

Push the roller shade against the idle end (1) and slide it out of the bracket (2).