

RB 500 Roller Shade



Sleek, strong, and precisely engineered, the RB 500 roller shade operating system is the driving force behind window coverings large and small. Easy to install, simple to use, and built to last.

Features

- Patented clutch system provides smooth, quiet, and easy lift capabilities
- Modular operating system accommodates manual chain, manual crank and electric motorized applications
- Universal spring-loaded end plug mounts shades securely and provides for smooth and easy installation
- Counter balance weight system provides ease of lifting roller shades over large expanses
- Clear plastic chain tensioner, compliant with WCMA safety standards
- Roller shade tubes engineered to span large windows
- Backed by our Lifetime Guarantee

HunterDouglasHospitality

LAS VEGAS • CHICAGO | PHONE 800.229.5300 • FAX 773.634.5123

EMAIL: CustomerSupport@HunterDouglasHospitality.com

RB 500 Roller Shade

Hunter Douglas Hospitality offers 3 options for clutch systems on the RB 500 Roller Shade.

Standard Clutch System

- Inside, outside or ceiling mount
- Plastic clutch
- Steel mounting bracket
- Stainless Steel chain operation with 110lb breaking strength
- Plastic bracket cover (outside or ceiling mount only)

Standard Clutch



Standard Bracket

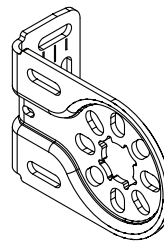

Standard Bracket Cover

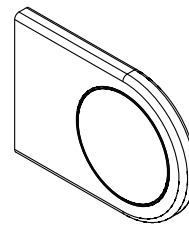

Architectural Clutch System

- Outside or ceiling mount
- Decorative die-cast metal clutch
- Decorative steel mounting bracket
- Decorative metal bracket disc and screw cover

Architectural Clutch



Architectural Bracket

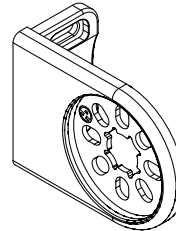

Architectural Bracket Cover



Heavy Duty Clutch System

- Inside, outside or ceiling mount
- Die-cast metal clutch
- Steel mounting bracket
- Plastic bracket cover (outside or ceiling mount only)
- Geared clutch with auto stop feature*
- Features easy-lift counterbalance clutch system with integrated spring support*

Heavy Duty Clutch

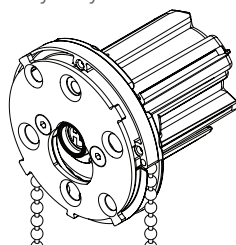

Heavy Duty Bracket

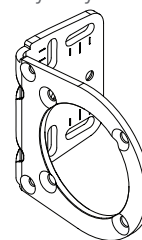

Heavy Duty Bracket Cover

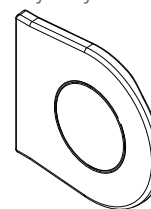

*based on shade size and weight

Additional Options

Standard or Heavy Duty Clutch System with Fascia

- 3" or 4" fascia with 2.75" bottom closure return (fascia size determined by fabric and shade size)
- Locking safety system prevents unintentional removal of the shade from its brackets
- Reverse roll profile available

Standard or Heavy Duty Clutch System with Blockout

- 3" or 4" fascia with 2.75" bottom closure return (fascia size determined by fabric and shade size)
- Locking safety system prevents unintentional removal of the shade from its brackets
- 2.52" wide side channels with wool pile inserts and end caps
- Top and back closure to prevent light leakage above fascia
- RB 500 Bottom bar with wool pile insert to prevent light leakage at sill
- All mounting is hidden for a clean look

Integrated Leveling Device

- Allows for easy adjustment after installation
- Works with all three clutch systems

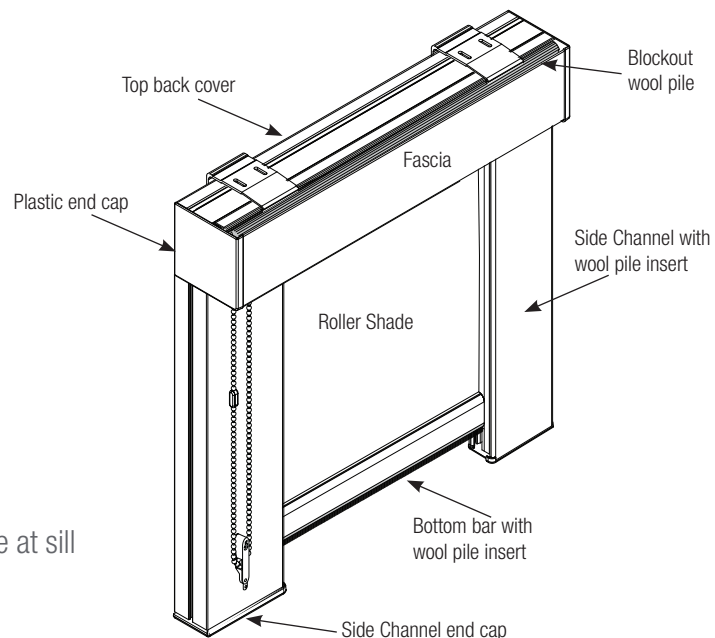

0939SHTRB500

HunterDouglasHospitality

LAS VEGAS • CHICAGO | PHONE 800.229.5300 • FAX 773.634.5123

EMAIL: CustomerSupport@HunterDouglasHospitality.com